



WiFi Tank Level Monitor
Installation Instructions

COMPATIBILITY

To install the Tank Utility remote level monitor, you will need the following:



A WiFi connection at your tank site



An Apple or Android smartphone or tablet



A propane tank with a Remote-Ready Dial

DIAL REPLACEMENT

Remote-Ready dials have a slot that a tank monitor can slide into. If you do not have a compatible dial, Tank Utility sells and supports the installation of replacement Remote-Ready Dials. For propane tanks, this upgrade can often be completed without depressurizing the tank. Professional installation by a delivered fuel professional is recommended.

WIFI

Tank Utility monitors use the 2.4 GHz frequency and cannot be connected to networks with a captive portal or firewalls or WEP security types. Please contact your internet service provider if you need assistance understanding the details of your network.

WATCH THE VIDEO

Before you start, watch the installation video at <http://www.tankutility.com/wifi-setup>

CONTENTS

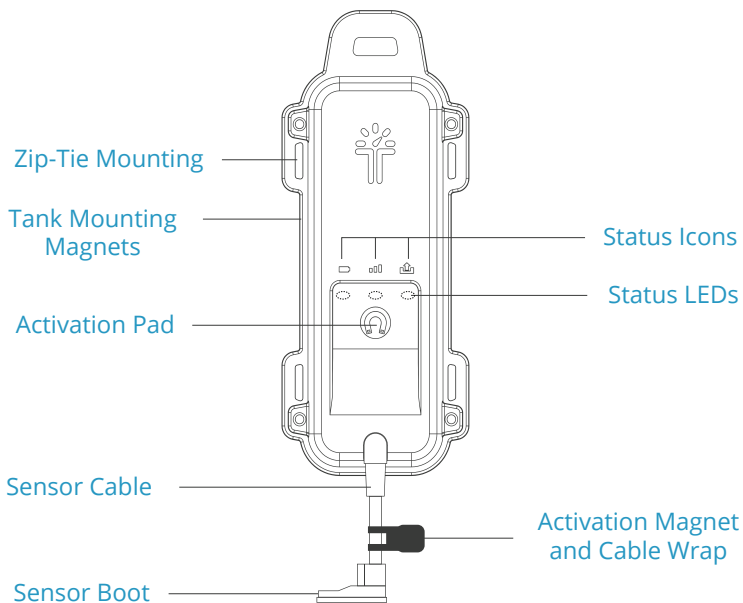

Tank Monitor

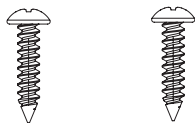

Self-Tapping Mounting Screws

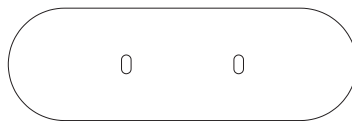

Mounting Bracket

MONITOR SETUP

STEP 1: Attach The Sensor To Your Tank's Dial

If your Remote-Ready Dial has a black **dust cap**, you will first need to remove it by simultaneously pulling up on the tab while sliding the dust cap out of the dial.

If applicable, route the cable through the hole in the tank's collar or lid.

Slide the **sensor** into the slot in the dial until you feel it click.

If you don't have a compatible dial, please go to shop.tankutility.com/products/dial-replacement 

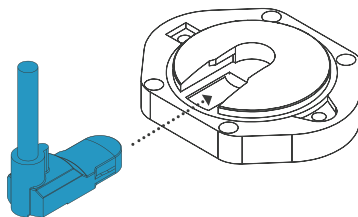
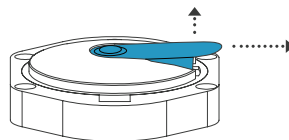

MONITOR SETUP

STEP 2: Get The Tank Utility Setup App

Go to www.tankutility.com/getapp to download the Tank Utility Setup App, or search for “Tank Utility Setup” on the Play Store or Apple Store.



Open the app, and select your monitor.



MONITOR SETUP

STEP 3: Turn Your Monitor On And Connect Your WiFi Network

Follow the instructions in the Setup App to hold the **activation magnet** (attached to the cable) to the **activation pad** (denoted by the magnet icon) on the monitor for 2 seconds, and remove when the middle LED flashes purple.

Please refer to the “Troubleshooting” section of this guide if your monitor shows any red LEDs. ⚠

Continue to follow the instructions in the Tank Utility Setup App to connect your monitor to your WiFi network. 3 aqua LEDs indicate a successful transmission.

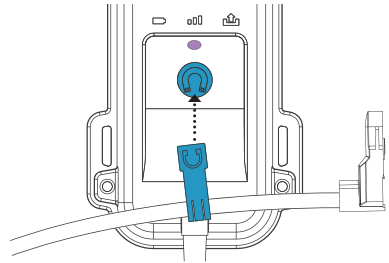

Hold the activation magnet to the activation pad until the middle LED flashes purple.

MONITOR SETUP

STEP 4: Configure Your Device In The Tank Utility App

Download and open the Tank Utility monitoring app. You can also access the web app at app.tankutility.com



Enter the **8 digit ID number** of your monitor into the app. The ID number is listed on the back of the device.

Assign a name, address, and details about your propane tank to your monitor. These details will help us calculate your tank level and fuel usage accurately.

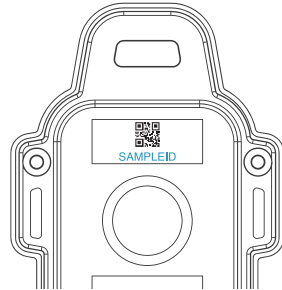

MONITOR SETUP

STEP 5 : Mount The Monitor

FOR ABOVE GROUND TANKS

The underside of the monitor has two protruding magnetic feet which can be used to mount the monitor on either the tank or the lid.

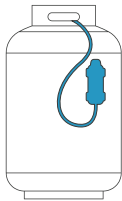

On **vertical tanks**, mount the monitor with the cable pointing downwards.

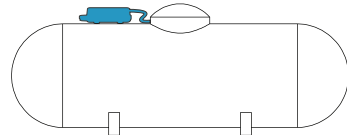

On **horizontal tanks**, mount the monitor on top of the tank.

NOTE: Do not place the tank monitor under a steel lid or inside the collar since this can prevent the monitor from connecting to the cellular network.

FOR BELOW GROUND TANKS

It is best to securely attach the monitor to the top of the lid. If the lid is not metal, use the included **self-tapping screws** to attach the **mounting bracket** to the non-metal lid to provide a place for magnet mounting.

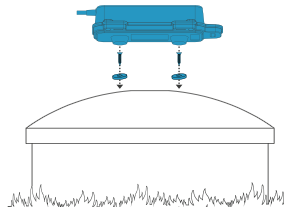

TROUBLESHOOTING

When the monitor is prompted to send a reading each LED will blink in succession. Each LED will turn solid aqua blue when the corresponding step is completed. If a problem is encountered, the LED will turn red.



BATTERY VOLTAGE

The batteries need to be replaced.



NETWORK ACCESS

The monitor cannot connect to the Tank Utility server. This could be because of a poor WiFi signal or a network setting that blocks Tank Utility from accessing the internet.



READING CONFIRMATION

The monitor has not received a confirmation of a successful reading.

Prompt A Reading

The WiFi monitor sends a reading every 24 hours. To force a reading to be sent, hold the **activation magnet** to the **activation pad** for 3 seconds, and release when the LEDs flash aqua blue.

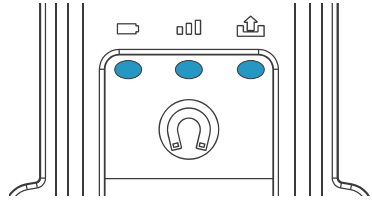

Hold activation magnet to pad until 3 LEDs flash aqua blue, then remove magnet.

Enter New WiFi Credentials

Open the Tank Utility Setup App, as described in step 2 of Monitor Setup

Follow the instructions in the Setup App to hold the **activation magnet** (attached to the cable) to the **activation pad** (denoted by the magnet icon) on the monitor for up to 10 seconds and remove when the middle LED turns purple.

Follow the steps outlined in the Setup App to complete the setup process with new WiFi credentials.

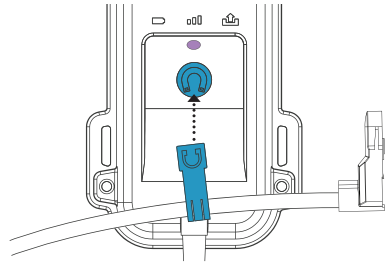

Hold the activation magnet to the activation pad until the middle LED turns purple.

Turn Off The Tank Monitor

This will prevent the monitor from sending additional readings. Hold the **activation magnet** over the **activation pad** for approximately 15 seconds until all 3 LEDs are red. Remove the **activation magnet** while all 3 LEDs are red.

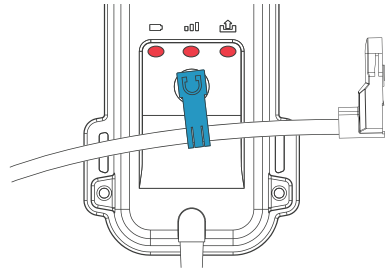

Battery Replacement

To replace your batteries, remove the 4 screws from the tabs on the enclosure and remove the base. Batteries must be unused Energizer Ultimate Lithium L91. Using used batteries or a different model void the warranty. When closing the monitor, attach the base with screws fastened tightly, to 9 inch-pounds. Failure to tighten properly will void the warranty.

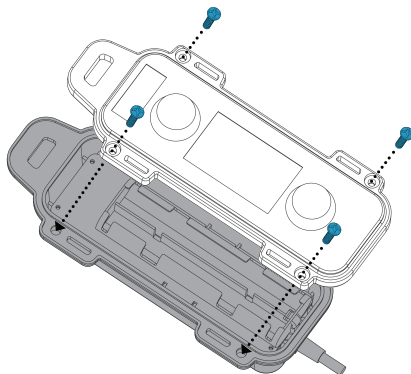
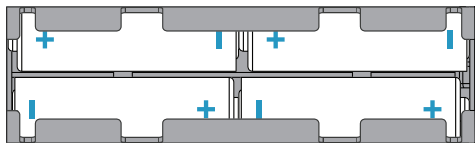

OUR ENHANCED EXPERIENCE GUARANTEE

We will replace, repair, or upgrade this product as necessary. Our two-year warranty is our statement that we stand behind our product, but our commitment doesn't stop there. We're committed to you as an energy consumer and will do what it takes to make sure you have the information you need about your tank level. When you partner with Tank Utility to provide products, you also inherit our relentless pursuit of the best tank monitoring experience.

Tank Utility, Inc. Two Year Limited Warranty

THIS LIMITED WARRANTY CONTAINS IMPORTANT INFORMATION ABOUT YOUR RIGHTS AND OBLIGATIONS, AS WELL AS LIMITATIONS AND EXCLUSIONS THAT MAY APPLY TO YOU.

1. WHAT THIS LIMITED WARRANTY COVERS; PERIOD OF COVERAGE

Tank Utility, Inc. ("Tank Utility"), 87 Summer St, Boston, Massachusetts USA, warrants to the owner of the enclosed product that the product contained in this box ("Product") will be free from defects in materials and workmanship for a period of two (2) years from the date of delivery following the original retail purchase (the "Warranty Period"). If the Product fails to conform to this Limited Warranty during the Warranty Period, Tank Utility will, at its sole discretion, either (a) repair or replace any defective Product or component; or (b) accept the return of the Product and refund the money actually paid by the original purchaser for the Product. Repair or replacement may be made with a new or refurbished product or components, at Tank Utility's sole discretion. If the Product or a component incorporated within it is no longer available, Tank Utility may, at Tank Utility's sole discretion, replace the Product with a similar product of similar function. This is your sole and exclusive remedy for breach of this Limited Warranty. Any Product that has either been repaired or replaced under this Limited Warranty will be covered by the terms of this Limited Warranty for the longer of (a) ninety (90) days from the date of delivery of the repaired Product or replacement Product, or (b) the remaining Warranty Period. This Limited Warranty is transferable from the original purchaser to subsequent owners, but the Warranty Period will not be extended in duration or expanded in coverage for any such transfer.

2. TOTAL SATISFACTION RETURN POLICY

If you are the original purchaser of the Product and you are not satisfied with this Product for any reason, you may return it in its original condition within thirty (30) days of the original purchase and receive a full refund.

3. WARRANTY CONDITIONS; HOW TO GET SERVICE IF YOU WANT TO CLAIM UNDER THIS LIMITED WARRANTY

Before making a claim under this Limited Warranty, the owner of the Product must (a) notify Tank Utility of the intention to claim by visiting tankutility.com/support during the Warranty Period and providing a description of the alleged failure, and (b) comply with Tank Utility's return shipping instructions. Tank Utility will have no warranty obligations with respect to a returned Product if it determines, in its reasonable discretion after examination of the returned Product, that the Product is an Ineligible Product defined below).

4. WHAT THIS LIMITED WARRANTY DOES NOT COVER

This Limited Warranty does not cover the following (collectively “Ineligible Products”): Products marked as “sample” or “Not for Sale”, or sold “AS IS”; or Products that have been subject to: (a) modifications, alterations, tampering, or improper maintenance or repairs; (b) handling, storage, installation, testing, or use not in accordance with instructions provided by Tank Utility; (c) abuse or misuse of the Product; (d) breakdowns, fluctuations, or interruptions in electric power or the telecommunications network; or (e) Acts of God, including but not limited to lightning, flood, tornado, earthquake, or hurricane. This Limited Warranty does not cover consumable parts, including batteries, unless damage is due to defects in materials or workmanship of the Product, or software (even if such consumable parts or software are packaged or sold with the product). Tank Utility recommends that you use only authorized service providers for maintenance or repair. Unauthorized use of the Product or software can impair the Product’s performance and may invalidate this Limited Warranty.

5. DISCLAIMER OF WARRANTIES

EXCEPT AS STATED ABOVE IN THIS LIMITED WARRANTY, AND TO THE MAXIMUM EXTENT PERMITTED BY APPLICABLE LAW, TANK UTILITY DISCLAIMS ALL EXPRESS, IMPLIED, AND STATUTORY WARRANTIES AND CONDITIONS WITH RESPECT TO THE PRODUCT, INCLUDING THE IMPLIED WARRANTIES OF MERCHANTABILITY AND FITNESS FOR A PARTICULAR PURPOSE. TO THE MAXIMUM EXTENT PERMITTED BY APPLICABLE LAW, TANK UTILITY ALSO LIMITS THE DURATION OF ANY APPLICABLE IMPLIED WARRANTIES OR CONDITIONS TO THE DURATION OF THIS LIMITED WARRANTY.

6. LIMITATION OF DAMAGES

IN ADDITION TO THE ABOVE WARRANTY DISCLAIMERS, IN NO EVENT WILL TANK UTILITY BE LIABLE FOR ANY CONSEQUENTIAL, INCIDENTAL, EXEMPLARY, OR SPECIAL DAMAGES, INCLUDING ANY DAMAGES FOR LOST DATA OR LOST PROFITS, ARISING FROM OR RELATING TO THIS LIMITED WARRANTY OR THE PRODUCT, AND TANK UTILITY’S TOTAL CUMULATIVE LIABILITY ARISING FROM OR RELATED TO THIS LIMITED WARRANTY OR THE PRODUCT WILL NOT EXCEED THE AMOUNT ACTUALLY PAID FOR THE PRODUCT BY THE ORIGINAL PURCHASER.

7. LIMITATION OF LIABILITY

THE TANK UTILITY ONLINE SERVICES (“SERVICES”) PROVIDE YOU INFORMATION (“PRODUCT INFORMATION”) REGARDING YOUR TANK UTILITY PRODUCTS OR OTHER PERIPHERALS CONNECTED TO YOUR PRODUCTS (“PRODUCT PERIPHERALS”). THE TYPE OF PRODUCT PERIPHERALS THAT MAY BE CONNECTED TO YOUR PRODUCT MAY CHANGE FROM TIME TO TIME. WITHOUT LIMITING THE GENERALITY OF THE DISCLAIMERS ABOVE, ALL PRODUCT INFORMATION IS PROVIDED FOR YOUR CONVENIENCE, “AS IS”, AND “AS AVAILABLE”. TANK UTILITY DOES NOT REPRESENT, WARRANT, OR GUARANTEE THAT PRODUCT INFORMATION WILL BE AVAILABLE, ACCURATE, OR RELIABLE OR THAT PRODUCT INFORMATION OR USE OF THE SERVICES OR PRODUCT WILL PROVIDE SAFETY IN YOUR HOME. YOU USE ALL PRODUCT INFORMATION, THE SERVICES, AND THE PRODUCT AT YOUR OWN DISCRETION AND RISK. YOU WILL BE SOLELY RESPONSIBLE FOR (AND TANK UTILITY DISCLAIMS) ANY AND ALL LOSS, LIABILITY, OR DAMAGES, INCLUDING TO YOUR WIRING, FIXTURES, ELECTRICITY, HOME, PRODUCT, PRODUCT PERIPHERALS, COMPUTER, MOBILE DEVICE, AND ALL OTHER ITEMS AND PETS IN YOUR HOME, RESULTING FROM YOUR USE OF THE PRODUCT INFORMATION, SERVICES, OR PRODUCT. PRODUCT INFORMATION PROVIDED BY THE SERVICES IS NOT INTENDED AS A SUBSTITUTE FOR DIRECT MEANS OF OBTAINING THE INFORMATION. FOR EXAMPLE, A NOTIFICATION PROVIDED THROUGH THE SERVICE IS NOT INTENDED AS A SUBSTITUTE FOR AUDIBLE AND VISIBLE INDICATIONS IN THE HOME AND ON THE PRODUCT, NOR FOR A THIRD PARTY MONITORING SERVICE THAT MONITORS ALARM STATE.

8. YOUR RIGHTS AND THIS LIMITED WARRANTY

This Limited Warranty gives you specific legal rights. You may also have other legal rights that vary by state, province, or jurisdiction. Likewise, some of the limitations in this Limited Warranty may not apply in certain states, provinces or jurisdictions. The terms of this Limited Warranty will apply to the extent permitted by applicable law. For a full description of your legal rights you should refer to the laws applicable in your jurisdiction and you may wish to contact a relevant consumer advisory service.

Tank Utility, Inc.
Support@TankUtility.com
Support.TankUtility.com